

## Introduction

Your Veeder-Root brand C628 Elapsed Timer is one model in a family of 1/8 DIN units which offers breakthrough display technology as well as easy-to-program single-line parameters. Designed to provide instant visual feedback regarding an application's key input value, the C628 not only has a 0.71" high LED display (27% larger than other 1/8 DIN units), but also the ability to change display color based on process status (programmable parameter in Operation Mode). Easy programming is made possible via a help function and a secondary legend display.

This manual will guide you through the installation and wiring of your C628 unit with information on proper panel mounting and rear terminal layout and wiring instructions. In addition, the instrument's operation and programming modes are thoroughly explained. The Operation Mode provides day to day operation and allows editing of preset values. The Program Mode enables the configuration of various parameters prior to initial operation. These parameters include those for basic configuration as well as other settable features which will enhance the functionality and usability of the device.

This manual also provides information on the C628 Elapsed Timer's transistor and relay outputs, product specifications, and ordering and warranty procedures.



## Features

- AWESOME 0.71" high digit LED display
- Programmable color change display based on an event
- Programmable help function and secondary legend display
- Programmable for single input or cumulative operation
- Choice of NPN or PNP primary input
- Filter speed settable for 20, 200, or 10,000 Hz
- Standard outputs: one NPN transistor & one relay
- Front panel reset enable and preset/alarm lockout
- Optional RS-485 plug in card
- CE approved

## Index

Installation	
Panel Mounting	page 2
Wiring	page 3
Operation	
Front Panel	page 4
Operation Mode	page 5
Programming	
Program Mode	page 6-9
Appendix A	
Specifications	page 10
General	
Notes	page 11
Ordering Information	page 12
Warranty	page 12

**Technical Manual  
702138-0005**

**Veeder-Root brand  
Series C628  
Elapsed Timer  
(C628-6XXX)**

# INSTALLATION

## PANEL MOUNTING

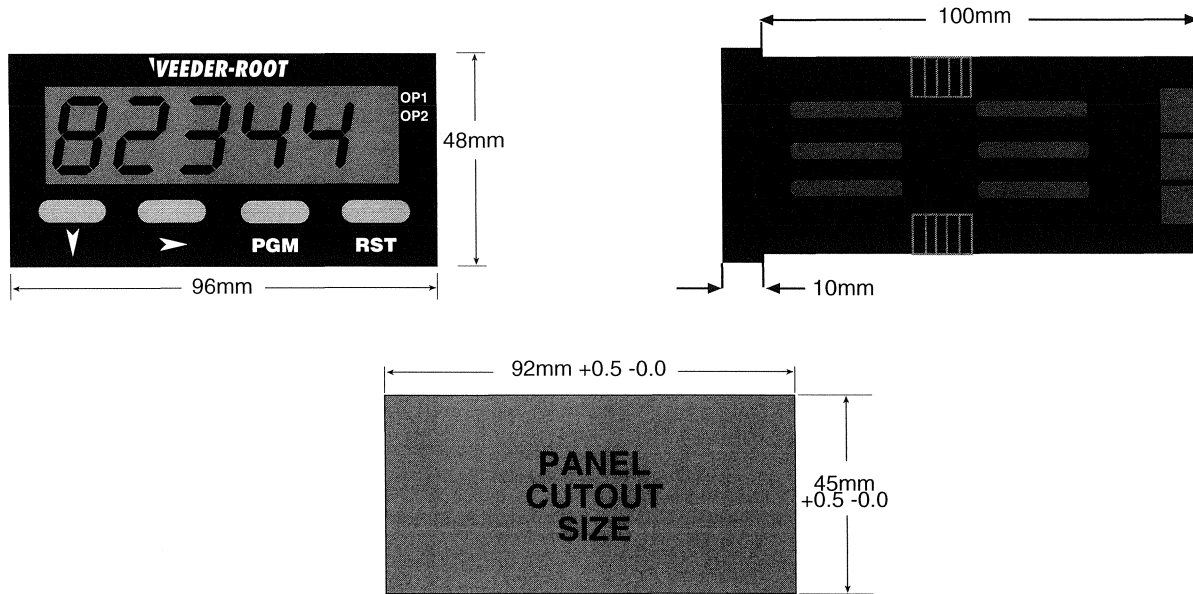

### Mounting Grooves

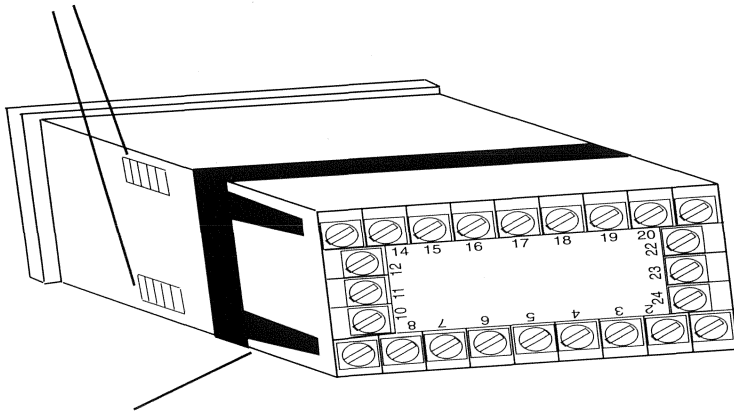

### Bracket Arm

The instrument can be mounted in a panel with a thickness of up to 6mm. The cutout(s) should be made based on the recommended panel opening illustrated in the drawing above.

Insert the unit in the panel through the cutout. Ensure that the panel gasket is not distorted and the instrument is positioned squarely against the panel. Slide the mounting clamp into place on the instrument, as shown to the left, and push it forward until it is firmly in contact with the rear face of the mounting panel and the tabs on the bracket arm are seated in the mounting grooves on the side of the unit.

The electronic components of the instrument can be removed from the housing after installation without disconnecting the wiring. To remove the components, grip the side edges of the panel and pull the instrument forward. Take note of orientation of the unit for subsequent replacement in the housing.

# INSTALLATION

## WIRING

### REAR TERMINAL CONNECTIONS

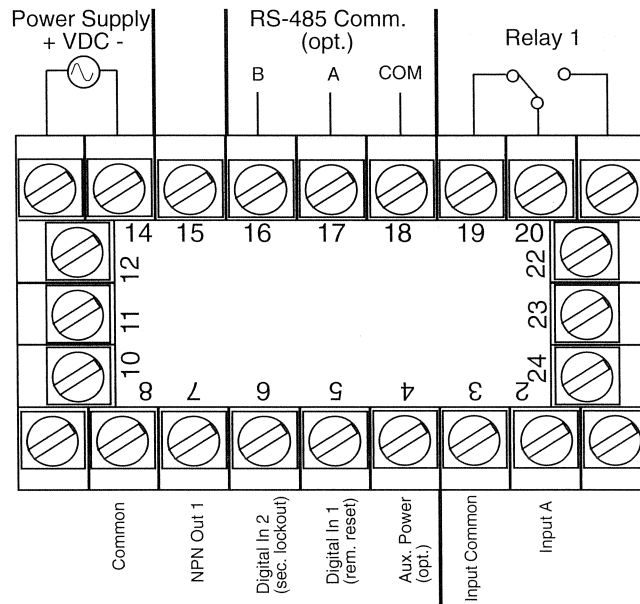

#### Timing Inputs

Terminal #2 is the connection for Input A, which is the start signal for time accumulation. The common connection for Input A is Terminal #3.

#### Control/Digital Inputs

A contact closure or NPN signal can be used to activate preconfigured functionality. Terminal #5 is used for a remote reset function, while Terminal #6 is a security function, that when active, will prohibit entry into Program Mode. Terminal #8 serves as the common for both of these inputs.

#### Auxiliary Power Output

A 9 - 15 VDC for powering external sensors up to 125 mA can be accessed by connecting the positive supply side of the sensor to Terminal #4 and the negative side to Terminal #8.

#### Input Power

For an AC powered unit, Terminal #13 serves as the line or Hot side connection for AC powered units and as the positive side for DC powered units. The neutral side for AC powered units and the negative side for DC powered units are connected to Terminal #14.

#### Transistor Outputs

Your unit comes standard with an NPN output which is activated by the preset. Transistor Output 1, which is tied to the Set Value, is on Terminal #7. Terminal #8 serves as the common connection for the transistor output.

#### Relay Outputs

Your unit comes standard with a relay output which is tied to the Set Value. Terminal #19 is NC, Terminal #20 is common, and Terminal #21 is NO.

#### Serial Communication

An RS-485 communication board, utilizing ASCII protocol, can be installed as an option. Terminals #16 & #17 serve as the B and A connections respectively, while Terminal #18 is connected as the common.

**Terminals 1, 9, 10, 11, 12, 15, 22, 23, & 24 are not used.**

# OPERATION

## FRONT PANEL

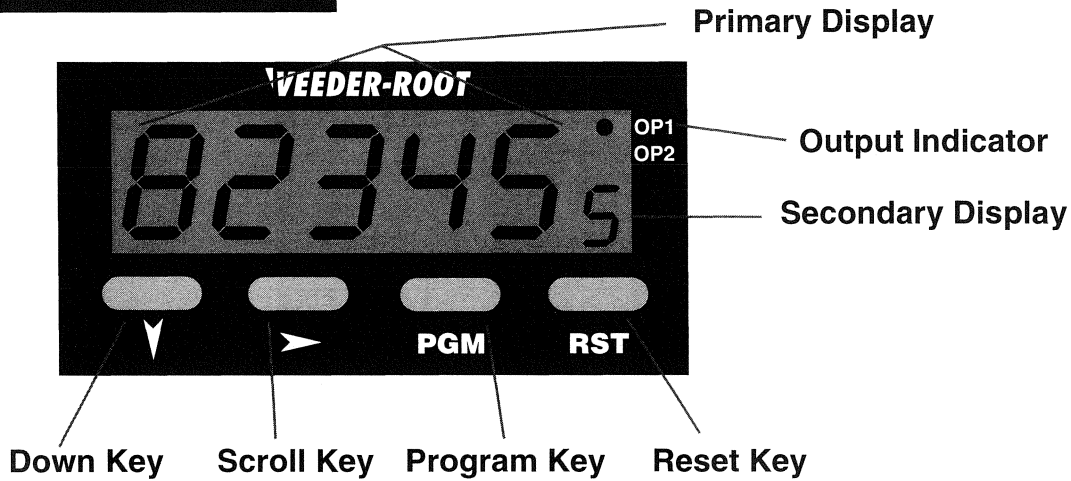

### Key Functions

Key	Function
Down	<p><i>In Operation Mode:</i> Used in edit operation to decrement the digit highlighted by the Scroll key.</p> <p><i>In Program Mode:</i> Used in Edit Operation to decrement the digit <b>highlighted</b> by the Scroll key, if the setting is a numerical value, or present the next in the series of choices for that parameter.</p>
Scroll	<p><i>In All modes:</i> Moves the unit into Edit Operation, which is indicated by the left most digit flashing. Successive presses of the key are used to move to the digit to be edited. Wrap around will occur from least significant digit to most significant digit.</p>
Program	<p><i>In Operation Mode:</i> Used to move between the time value display &amp; the set value and to enter an edited set value. <b>Holding the key down for 3 seconds</b> will cause the unit to enter Program Mode.</p> <p><i>In Program Mode:</i> Used to move from one parameter to the next and enter the edited parameter values. <b>Holding the key down for 3 seconds</b> will cause the unit to return to Operation Mode.</p>
Reset	<p><i>In Operation Mode:</i> Resets the time value to zero . This button can be disabled via the "Front Panel Reset Enable" parameter in Program Mode.</p> <p><i>In Program Mode:</i> No function.</p>
Down & Scroll together	<p><i>In All modes:</i> Will abort an Edit Operation and return the preset/parameter to its previous value.</p>

### Display Functions

Display	Function
Primary	<p><i>In Operation Mode:</i> Default display is the time value. Can be scrolled using the program key to display the Set value. If the "Help" function is enabled, this display will first show the parameter description for 3 seconds (see page 5 for example).</p> <p><i>In Program Mode:</i> Displays the value or selection for the current parameter. If the "Help" function is enabled, this display will first show the parameter description for 3 seconds (see page 6 for example).</p>
Secondary	<p><i>In Operation Mode:</i> Indicates numerically if the Set Value is being viewed on the primary display. This display is blank when the Time Value is being shown.</p> <p><i>In Program Mode:</i> Provides a 1 digit alpha character to indicate which parameter value is being shown on the primary display.</p>
Output Indicators	<p><i>In Operation Mode:</i> OP1 illuminates when Output 1 is active.</p> <p><i>In Program Mode:</i> No function.</p>

# OPERATION

## OPERATION MODE

### CHANGING A PARAMETER VALUE

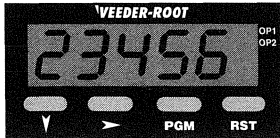

Default display is the present time value.

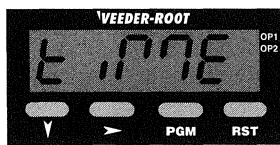

Pressing the Program Key will cause the display description to appear on the main display.\* If there is no key activity for 3 seconds, the primary display will switch back to the count value.

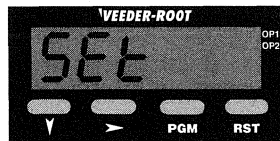

Continued pressing of the Program Key will scroll to the Set value. (See Parameter Sequence below.) The full parameter description will appear on the main display.\*

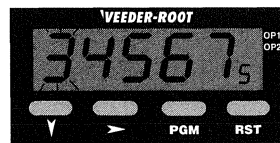

To change the Set value, press the Scroll Key. If there was no key activity for 3 seconds, the Set value will appear (one digit description shown on secondary display); however, press the Scroll Key in order to edit. The unit will now be in Edit Operation as signified by the most significant digit flashing.\*\*



Use the Scroll Key to move from left to right and highlight the digit that needs to be changed. Wrap around will occur from the least significant to the most significant digit.

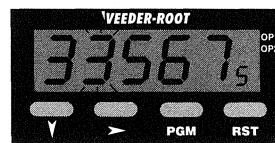

Use the Down Key to decrement the digit until the desired value appears. The display will wrap around from 0 to 9.

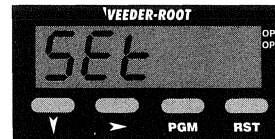

After the desired digits have been changed, press the Program Key to enter the new value. The new value will appear on the main display without any flashing digits. Press the Program Key again and the parameter description will appear on the main display.

\*Parameter descriptions will not appear on the primary display if the "Help" function has been disabled.

\*\* Edit Operation cannot be accessed if the Preset Lock has been enabled in Program Mode.

### PARAMETER SEQUENCE

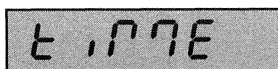

#### Time Value

Function: Displays present time value  
Range: 0 to 99999

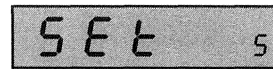

#### Set Value

Function: Defines the value at which Output 1 will be activated  
Adjustment Range: 0 to 99999  
Default Value: 0

# PROGRAMMING

## PROGRAM MODE

### ENTERING PROGRAM MODE AND BASIC OPERATION

The Program Mode can be accessed from the Operation Mode by holding the Program Key for 3 seconds.

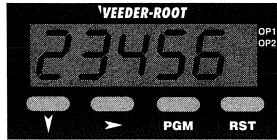

 for 3 seconds  
PGM

The name of the first parameter will appear on the primary display.\*

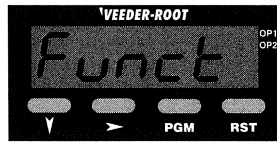

 PGM

Successive presses of the Program Key will scroll the display through the remaining parameters in the Program Mode. **To exit Program Mode, hold the Program Key for 3 seconds.**

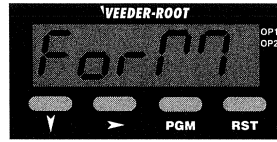

no key activity for 3 secs. or

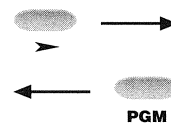

### Edit Operation

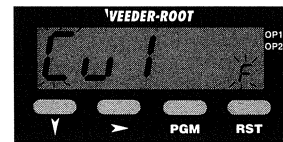

Pressing the Scroll Key or no key activity for 3 seconds will display the value for that parameter. The secondary display will indicate the one digit identifier for the parameter. The digit in the secondary display will flash to indicate the unit is in Program Mode. If the Scroll Key was pressed (instead of waiting 3 seconds), the unit is in Edit Operation, as indicated by the MSD flashing. If there had been no key activity for 3 seconds, press the scroll key to enter Edit Operation (MSD flashing). Use the scroll and edit buttons to change the value as in Operation Mode, described on page 5. Press the Program Key to enter any changes.

\* Parameter names will not appear on the main display if the "Help" function has been disabled in Program Mode.

### PARAMETER SEQUENCE

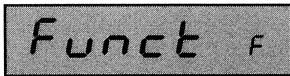

#### Function

*Function:* Determines how the Output 1 will operate in relation to the Set Value

*Adjustment Range:*



Cumulative: Elapsed time value will continue to accumulate during all instances when the input is active

Single: Time value will display the elapsed time of an individual input and will reset to zero for each successive new pulse

*Default Value:* Single

 PGM

# PROGRAMMING

## PROGRAM MODE Continued



### Time Format

*Function:* Sets the unit of measure for the time values that will be shown on the display in Operation Mode

*Adjustment Range:*



Seconds: Input pulses will be timed in seconds

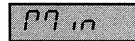

Minutes: Inputs pulses will be timed in minutes



Hours: Input pulses will be timed in hours



Minutes & Seconds: Input pulses will be timed in minutes and seconds



Hours & Minutes: Input pulses will be timed in hours and minutes



*Default Value:* Seconds



### Timing Direction

*Function:* Determines if the time value will increment from zero and change the state of the output at the set value (Up) or decrement from the set value and change the state of the output at zero (Down)

*Adjustment Range:*



Up: The unit will time up from zero and activate the output when the set value is reached



Down: The unit will begin at the set value and time down. The set value output will be activated when the time value reaches zero



*Default Value:* Up

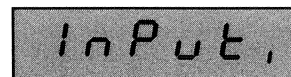

### Input Type

*Function:* Programs the unit to match the electrical characteristics of the input signal

*Adjustment Range:*

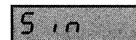

Sinking: The unit will accept a NPN or dry contact input which sinks voltage to common

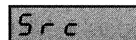

Source: The unit will accept a PNP input which sources voltage



*Default Value:* Sinking

# PROGRAMMING

## PROGRAM MODE Continued

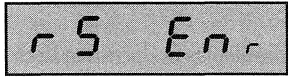

### Front Panel Reset Enable

*Function:* Determines whether the Front Panel Reset key can be used to reset the time value

*Adjustment Range:*



Enable: The time value can be reset while being viewed in Operation Mode by pressing the Front Panel Reset Key

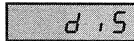

Disabled: The Front Panel Reset Key is disabled and the time value can only be reset through the Remote Reset Input

*Default Value:* Enable

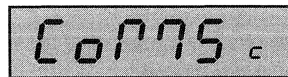

### Serial Communication Enabled

*Function:* Activates the RS-485 communication option board

*Adjustment Range:*



None: No communication board installed

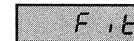

Fitted: A communication board is installed in the unit

*Default Value:* If ordered from the factory with the RS-485 board, the default will be "fitted". If the board is installed in the field, this parameter will need to be changed from its default of "none"

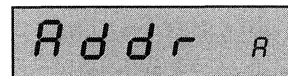

### Communication Address *(Appears only if communication board is installed and activated)*

*Function:* Defines the unique communication address of the counter

*Adjustment Range:* 1 to 99

*Default Value:* 1

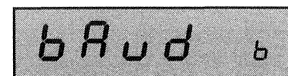

### Baud Rate *(Appears only if communication board is installed and activated)*

*Function:* Selects the serial communication speed

*Adjustment Range:*

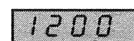

1200 BPS

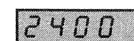

2400 BPS

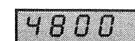

4800 BPS

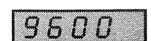

9600 BPS

*Default Value:* 4800





# PROGRAMMING

## PROGRAM MODE Continued

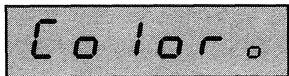

Color

### Display Color Change

*Function:* Defines the color of the display for prior to and after the preset value is reached

*Adjustment Range:*

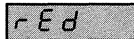

rEd

Red: The display will always be red

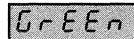

GrEEEn

Green: The display will always be green

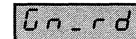

Gn\_r d

Green to Red: The display will be green prior to the Preset 1 value being reached. It will turn red after Preset 1 has been reached

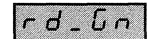

rd\_Gn

Red to Green: The display will be red prior to the Preset 1 value being reached. It will turn green after Preset 1 has been reached

*Default Value:* Green to Red

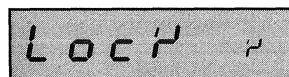

Lock

### Set Lock

*Function:* Determines whether the Set Value can be changed via the front panel

*Adjustment Range:*



En

Enable: Set value is read only

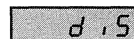

dIS

Disabled: Set value can be viewed and changed

*Default Value:* Disable

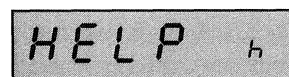

HELP

### Help Prompt

*Function:* Determines whether the multi-character parameter name will appear on the main display for 3 seconds prior to the parameter value appearing

*Adjustment Range:*

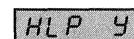

HLP Y

Help - Yes: Multi-character parameter descriptions will appear on the primary display. The value associated with that parameter will appear by pressing the scroll key or waiting for 3 seconds

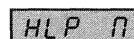

HLP N

Help - No: Only the parameter values will appear on the primary display. The parameter can be identified by a single digit in the secondary display

*Default Value:* Help - Yes

# APPENDIX A

## SPECIFICATIONS

### Time Inputs

Type: Sinking/Sourcing or Contact Closure  
Frequency: 10 kHz max.  
Logic: Low  $\leq$  2.0 VDC, High  $\geq$  3.0, 30V max.  
Impedance: 10 K $\Omega$  to common - Sourcing  
4.7 K $\Omega$  to +Voltage - Sinking

### Control Inputs

Type: Sinking, Edge Sensitive  
Logic: Low  $\leq$  2.0 VDC, High  $\geq$  3.0  
Impedance: 4.7 K $\Omega$  to +Voltage  
Response Time: 25 ms  
Function: Input 1: Remote Reset  
Input 2: Security Lockout

### Outputs

Solid State: NPN open collector, 30 VDC max, 100 mA max.  
Relay: SPDT, 5A resistive @ 110VAC  
Latency: 75  $\mu$  seconds, plus 8 ms for relay pull-in

### Approvals

General: CE  
EMC Susceptibility: Complies with EN50082-1: 1992,  
EN50082-2: 1995  
EMC Emissions: Complies with EN50081-1: 1992,  
EN50081-2: 1994  
Safety: Complies with EN61010-1: 1993

### Communication

Type: Serial asynchronous, UART to UART  
Data Format: Open ASCII: One start bit, even parity seven  
data bits, one stop bit  
Physical Layer: RS-485  
Maximum Zones: 99  
Baud Rate: Selectable from 9600, 4800, 2400, or 1200

### Electrical

Supply Voltage: 90-264 VAC, 50/60 Hz, or 20-50 VAC/VDC  
Power Consumption: 4 Watts  
Access. Power Supply: 9-15 (unregulated VDC), 125 mA max.

### Display

Type: Red/Green, 7 segment LED, 5 digits primary  
display, single digit secondary display  
Height: 0.71" (18mm) primary display,  
0.3" (7mm) secondary display  
Annunciators: Output 1 status

### Physical

Dimensions: 48mm x 96mm, 110mm deep  
Mounting: Panel mount (mounting bracket supplied),  
45mm x 92mm cutout  
Terminals: Screw type - combination head  
Front Panel Rating: NEMA 4X/IEC IP65  
Case Material: GE Lexan 940  
Weight: 0.56 lbs.

### Environmental

Operating Temp.: 0° to 55° Celsius, 32° to 131° Fahrenheit  
Storage Temp.: -20° to 80° Celsius, -4° to 176° Fahrenheit  
Relative Humidity: 20% to 95% non-condensing

# GENERAL

## ORDERING INFORMATION

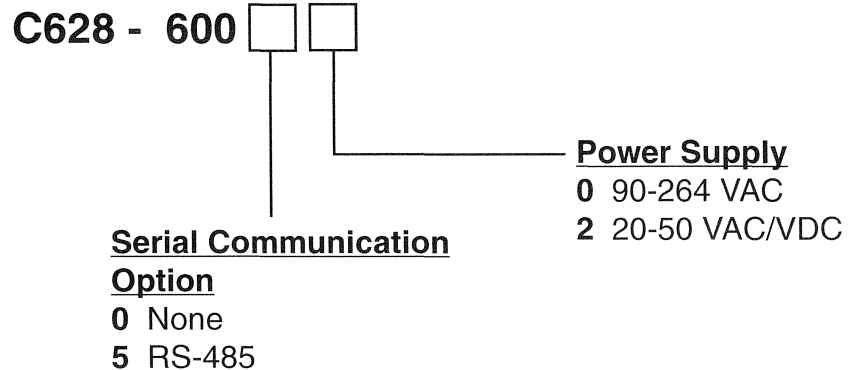

Additional options can be field installed through plug-in boards which can be ordered separately.

<u>Description</u>	<u>Part #</u>
RS-485 Comm. Board	T50-005

## WARRANTY

Standard products manufactured by the Company are warranted to be free from defects in workmanship and material for a period of one year from the date of shipment, and products which are defective in workmanship or material will be repaired or replaced, at the option of the Company, at no charge to the Buyer. Final determination as to whether a product is actually defective rests with the Company. The obligation of the Company hereunder shall be limited solely to repair and replacement of products that fall within the foregoing limitations, and shall be conditioned upon receipt by the Company of written notice of any alleged defects or deficiency promptly after discovery within the warranty period, and in the case of components or units purchased by the Company, the obligation of the Company shall not exceed the settlement that the Company is able to obtain from the supplier thereof. No products shall be returned to the Company without its prior consent. Products which

the Company consents to have returned shall be shipped F.O.B. the Company's factory. The Company cannot assume responsibility or accept invoices for unauthorized repairs to its components, even though defective. The life of the products of the Company depends, to a large extent, upon the type of usage thereof, and THE COMPANY MAKES NO WARRANTY AS TO FITNESS OF ITS PRODUCTS FOR SPECIFIC APPLICATIONS BY THE BUYER NOR AS TO PERIOD OF SERVICE UNLESS THE COMPANY SPECIFICALLY AGREES OTHERWISE IN WRITING AFTER THE PROPOSED USAGE HAS BEEN MADE KNOWN TO IT.

THE FOREGOING WARRANTY IS EXCLUSIVE AND IN LIEU OF ALL OTHER WARRANTIES EXPRESSED OR IMPLIED, INCLUDING, BUT NOT LIMITED TO ANY WARRANTY OF MERCHANTABILITY OR OF FITNESS FOR A PARTICULAR PURPOSE.

Printed in U.S.A.  
702138-0005  
March 1998  
Revision none

 **Danaher Controls**

1675 Delany Road  
Gurnee, IL 60031-1282  
Phone: 847.662.2666  
Fax: 847.662.6633